

SPECIFICATION

FD-600E series waterproof power supply

Product Name: FD-600E-XXXX

Summarize: 600W LED Driver

Version: V00

Release date: 2022-02-24

Customer ID : _____

Customer Model : _____

Products Code : _____

Sample Model : _____

Version : _____

GNATURE AND SEAL BY US		
Date:	2022/02/24	
Prepared By	Checked By	Approved By
Yajuan Lei	Zhuanhong Wu	Jafei Lin

Please confirm and send it back with signature within 7 days. Otherwise we will assume your acceptance. And if any quality dissent, there will be an executor according to this product specification.		
CUSTOMER APPROVED SIGNATURE		
Customer Model No:		
Date:		
ENG	QA	OTHER

Feature:



- ◆ IP65
- ◆ Max output power 600W.
- ◆ Constant current design.
- ◆ 3 in 1 dimming mode:0-10V,PWM,RX
- ◆ Smoothly dimming(0-100%),can dim to off.
- ◆ CE UL FCC Certified
- ◆ Surge protection :Differential mode:6KV.Common mode:6KV
- ◆ PROTECTION: Short Circuit, Open Circuit
- ◆ Auxiliary output 12V/200mA .
- ◆ Dimming signal is isolated from LED output.



Application:

Street lights、 High bay lights

Introduction

The document details the electrical, mechanical and environmental specifications of a 600W constant current LED driver with 0-10V Dimming. This LED driver is only suitable for LED load.

Model and Key parameters Table 1

Model	power (W)	Output voltage (V)	Max output voltage(Vdc)	output current (A)	Efficiency(%) @120V	Efficiency(%) @230V
FD-600E-056*/B/C/D/Z	600	27-56	58	6.7-13.5A	91	93

Model code naming rules

FD-600E-056B-XXXX

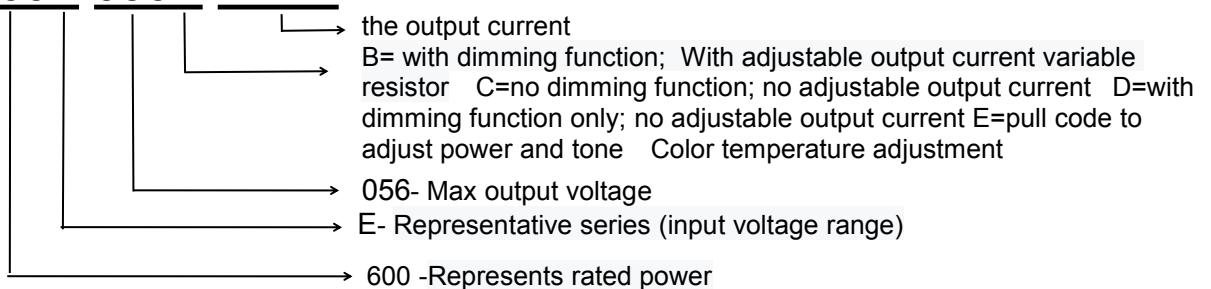

■ Technical data

Input characteristics	
Input Voltage	100-277Vac
Input Frequency	50/60Hz
Input Current (Typ.)	6.6A @100-277 Vac , 100% load
No load Voltage	5Wmax
Inrush Current	75Amax. @ 277Vac, 25°C
Power factor (Typ.)	PF>0.90 @ 100Vac, PF>0.90 @ 277Vac, 100% load, see chart 2
THD	THD<20% @ 100-277 Vac, 100% load see chart 3
Output characteristics	
Current accuracy	± 5%
Efficiency	≥91% @ 120 Vac, ≥93% @ 230Vac, see chart 1
Output Voltage	Table 1
Ripple and Noise	270mVp-p
Line Regulation	3%
Load Regulation	3%
Turn On Delay Time	Under normal conditions, the maximum delay time is 1 second
Programmed current	
Programmable current output range	the total output power does not exceed 600W (actual output voltage * actual output current = power), otherwise, it can not be guaranteed.
Protection functions	
Open circuit	When the LED disconnection the product is protected such as hiccup or when it is at the highest point of output voltage, the power supply shall be self-recovery when the fault condition is removed.
Short Circuit	The input power shall decrease when the output rail short, the power supply shall be self-recovery when the fault condition is removed.
Environmental conditions	
Operating Temperature	-40°C - +60°C
Operating Relative Humidity	10% to 90% RH, non-condensing
Storage Temperature	-40°C to +75°C
Storage Relative Humidity	10% to 90%RH, non-condensing (Sea level to 2,000 m)
Vibration	10 to 500HZ Sweep at constant acceleration of 1.0G (depth: 3.5mm)for 1 Hour for each of the perpendicular axes X, Y, Z.
Degrees of Protection	IP65
Safety compliance	
Dielectric Strength	P-S:3750VAC/5mA/60S P-E:1500VAC/5mA/60S P-E:500VAC/5mA/60S

Insulation Resistance	I/P-O/P:>50M Ohms / 500VDC / 25°C / 70% RH.
Leakage Current	The leakage current shall be less than 0.25mA for Class 2 at maximum input voltage
Safety Standard	UL:UL8750, CSA 250.13
EMI	FCC: PART 15B Subpart B; ANSI C63.4:2014
EMS	CE-EMC/RCM: EN61000-4-2,3,4,5,6,11 CCC:GB/T17626.2,3,4,5,6,11
ESD	Electrostatic discharge/immunity Severity Level Level3 air discharge: ±8KV Severity Level Level2 contact discharge: ±4KV performance criterion: B
RF	80-1000MHZ; Severity Level Level2/ 3V/M; Performance Criterion: A
Group pulse	1.0KV (Class B)
Surge Immunity	Severity Level Level2 Differential mode:6KV Severity Level Level3 Common mode:6KV. performance criterion: B
Reliability	
Life Time	≥5Years H@277Vac, 100% load. See lifetime vs. Tc curve for the details
MTBF	≥ 200,000H@ 25°C,277Vac, 80% load. (MIL-HDBK-217F)
Warranty	5 years
Others	
Dimensions	280*142.59*49.58mm (L*W*H) 不含线材
Weight	3750+/-10g
Remark	
<p>1、 It is recommended that customers install the over-voltage and under-voltage protection and surge protection devices in the lamp power supply circuit to ensure the safety of electricity consumption.</p> <p>2、 The led driver,as a part of the whole lamp is used in combination with the terminal equipment . As EMC performance is affected by LED lamps and wiring, terminal equipment manufactured supplier needs to re-confirm the EMC of the whole set of equipment.</p> <p>3、 When adjusting the output current of the led driver, ensuring that the total output power does not exceed the rated maximum power.</p> <p>4、 The parameters above including the power factor, THD and efficiency are all tested under the condition of environment temperature 25°C , humidity 50%, AC input 230V and 90% output load.</p>	

■ Dimming function

Dimming type	parameter	Min	Typ	Max	Remarks
0-10V 1-10V	Signal Level	0V		10V	
	Dim Range	10%		100%	Output current percentage
	Dim-off Level	0.6V	0.7V	0.8V	
	On Level	0.75V	0.85V	0.95V	
PWM	Signal Level	0V		10V	
	Signal Frequency	1KHz		2KHz	
	duty ratio	5%		100%	

■ Dimming range

Function			0-10V				PWM			RX		
Yes Or No			Y				Y			Y		
0-10V	0	1	2	3	4	5	6	7	8	9	10	open
Ir	0	10%	20%	30%	40%	50%	60%	70%	80%	90%	100%	100%
PWM	0%	10%	20%	30%	40%	50%	60%	70%	80%	90%	100%	open
Ir	0	10%	20%	30%	40%	50%	60%	70%	80%	90%	100%	100%

Note:

- it is the output current percentages.
- it is the typical datas.

■ **Efficiency vs. Load**

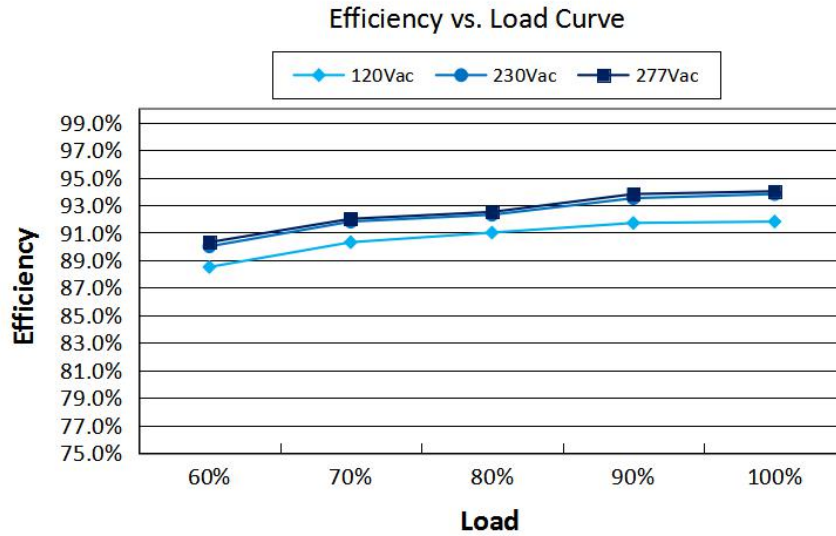

■ **Power Factor**

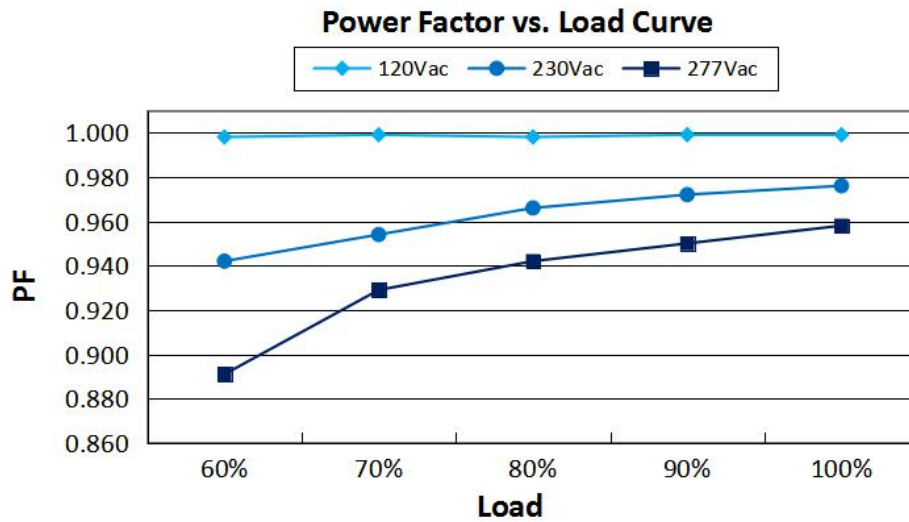

■ **THD vs. Load**

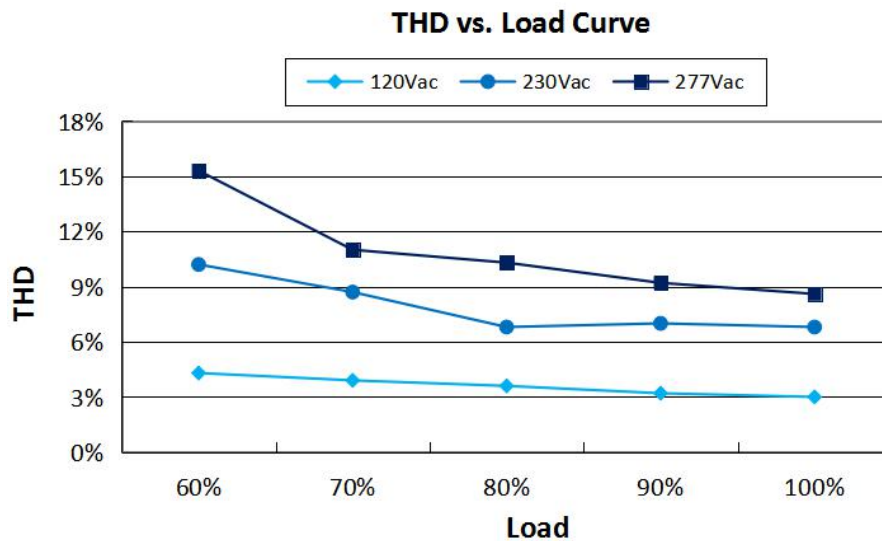

Power Curve

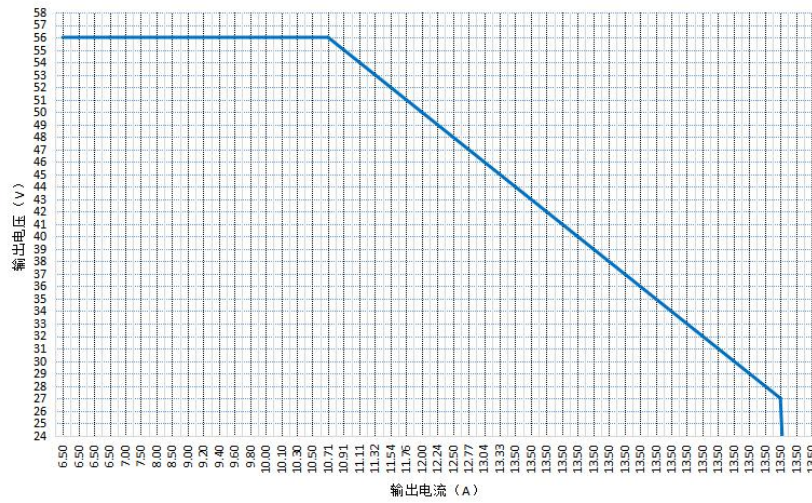

Output power VS Input voltg(50°C max.)

Output power VS Shell temperatur

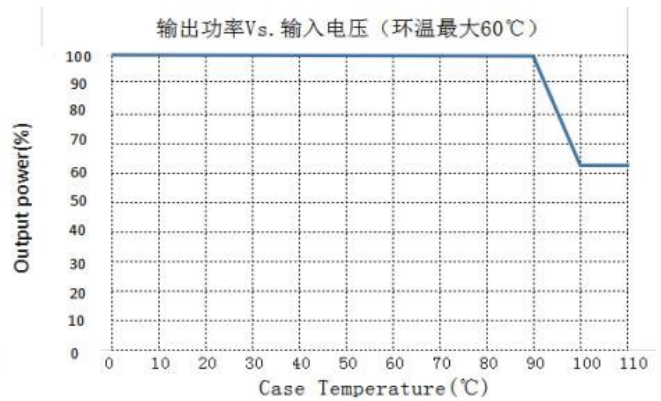
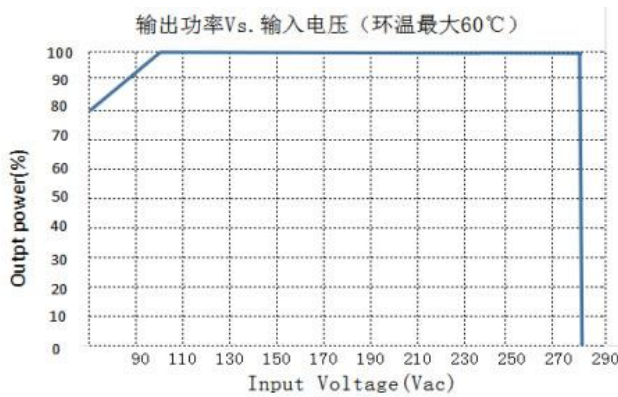

Dimming curve

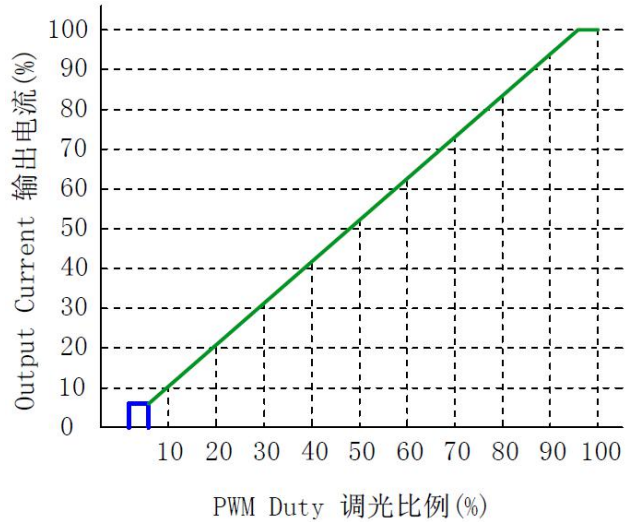
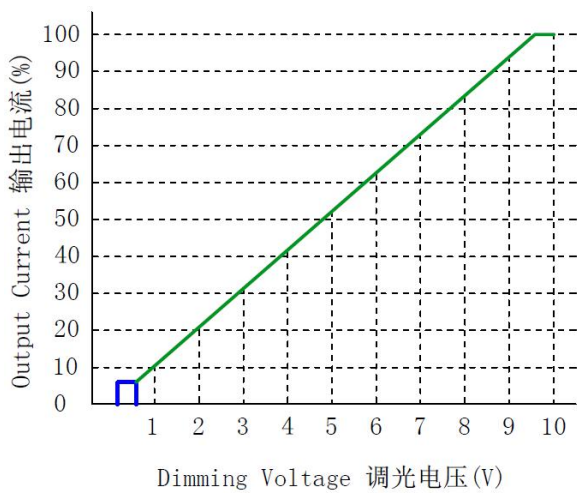

Life vs. Tc P5

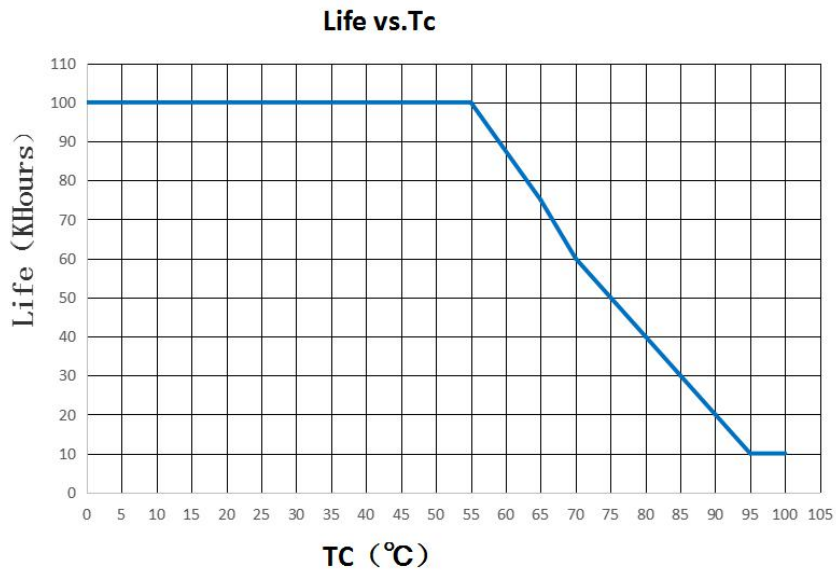

Dimensional Drawing (unit: mm)12V

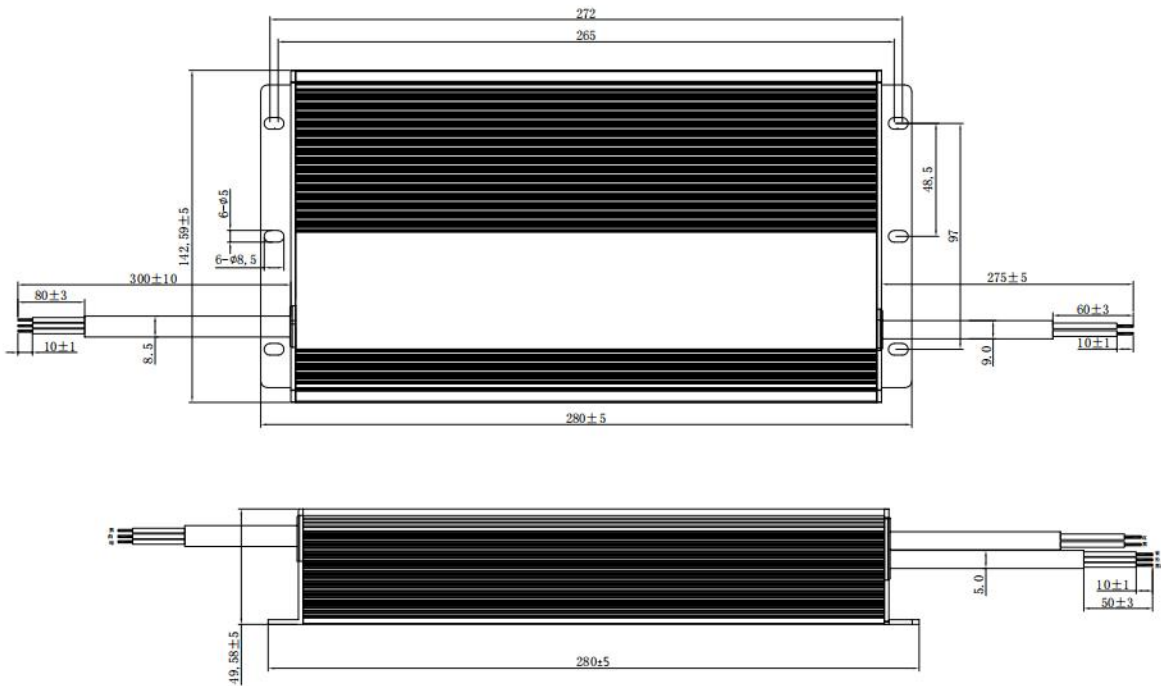

■ Dimensional Drawing (unit: mm)

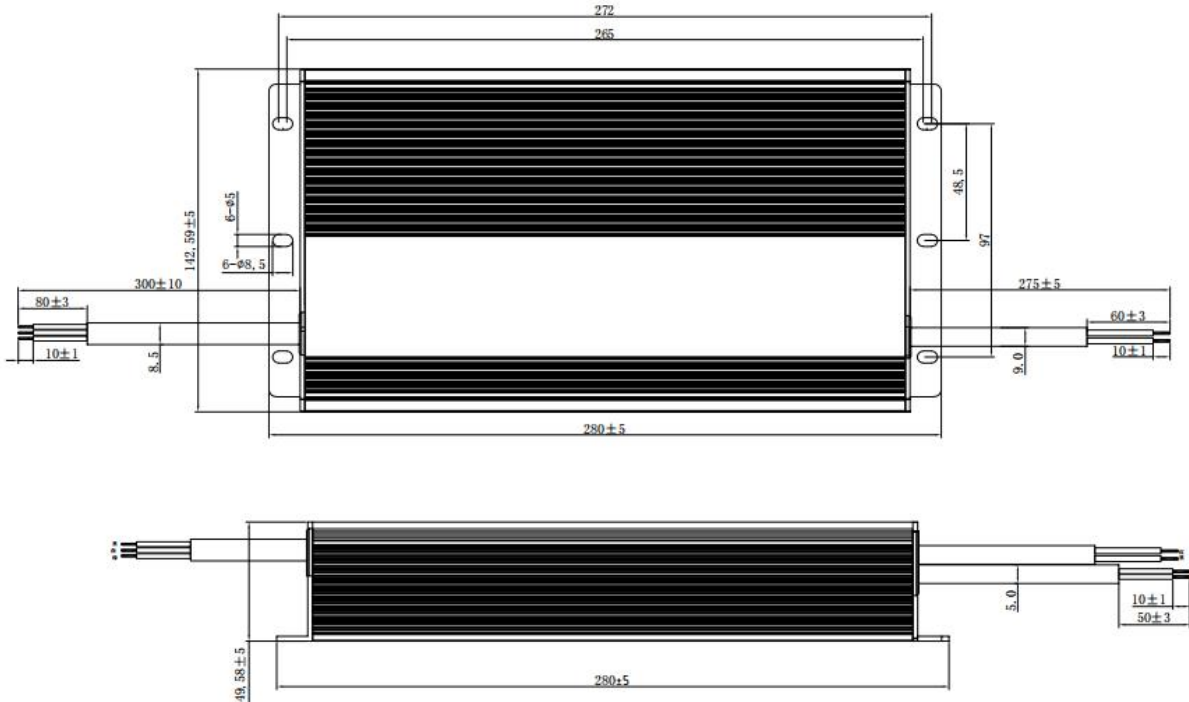

- Input Wire UL 300V 16#, Black-L, White-N, Green-PE
- Output Wire UL 300V 14#, Red_LED+, Black_LED-
- Dimming Wire UL 300V 22#, Purple_DIM+, Pink_DIM-
- Auxiliary Wire UL 300V 22#, Black roll white_ +12V

■ LABEL-With 12V

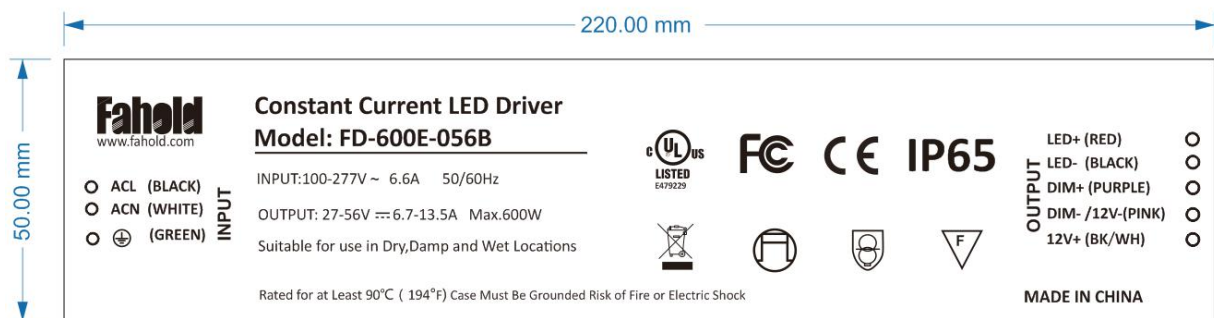

■ LABEL



Installation considerations

- 1.If the led driver has adjustable external potentiometer, we advise you to use 704 silicone to seal the hole well and then plug the waterproof rubber after adjusting output current,
- 2.Lightning protection level meets IEC61000-4-5 standard requirement. If you use the lightning prone area or the are with a complex power grid environment ,we suggest that you should equipped with professional lightning protection module on the led driver AC input terminal.

Package,Transportation & Storage

1.Package

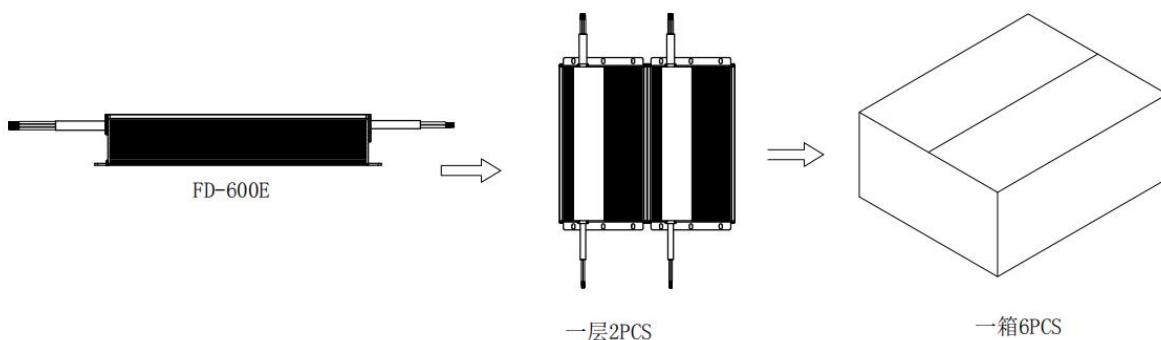

Packing case size	333mmx300mmx175mm (L×W×H)
Quantity	2PCS/Tier; 3Tier/Box; 6 PCS/Box
Weight	3750g±5%/PCS; 23.2Kg±5%/Box

2. Transportation

Packaging is designed suitable for transportation by truck, ship, and plane. The products should be shielded from sunshine, and loaded and unloaded carefully.

3. Storage

The product storage meet the standard of the GB 3873—83.

Product should be re-checked over 1 year and than will be used after they are qualified.

Disclaimer:

The content of this manual is made according to the existing information of the product. Due to the product version upgrade or other reasons, the content of the manual may be changed. Our company reserves the right to improve the product without prior notice, and reserves the right of final explanation for the performance description of the company's products. Our company is committed to improving the quality of products and constantly upgrading and optimizing the products.

Products Installation and Using should Note:

- Do not connect alternating current to DC output side and dimming side.
- Application do not exceed the power 600W.
- Do not use the Driver in parallel on the same lamp.
- This product is a constant current LED Driver, and only suitable for LED lamps and lanterns.

Safety and Attentions

In order to reduce the risk of personal injury, electric shock, fire, and power supply damage, please read the following specifications carefully and follow these rules to prevent danger.

- Do not install the Driver in the area with inflammable and explosive materials to avoid explosion and fire.
- Please do not disassemble the Driver and replace the components without permission, so as to avoid electric shock.

ECN History ECN

Rev	Description of Change		Changed Date	Notes
	Before	After		
00	Original Release	---	2022/02/24	